

**TOWEL WARMERS AND
DESIGN RADIATORS**



**HARMONY THAT
CREATES PERFECTION**





TOWEL WARMERS AND DESIGN RADIATORS

CONTENT

04 Introduction

DESIGN RADIATORS AND ELECTRIC RADIATORS

08 BAWA-VM SPA

10 FATALA-VM SPA

12 NEWA

14 NERO

16 LOWA-VM, KASAI

18 FATALA

20 ARUN-TWIN, BAWA

22 BAWA-TWIN, VELINO

24 FULDA, CAVALLY

27 MARANOVA SPEED AIR

28 LEVO-E

30 TAHITI SPEED AIR, FULDA-E

32 FATALA-E, BAWA-E

34 DELLA-E

TOWEL WARMERS

36 ABUNA-M

38 DION, DION-VM

REPLACEMENT RADIATORS

42 BAWA, BAWA-TWIN replacement radiators

44 FATALA replacement radiators

GENERAL INFORMATION

46 Accessories

49 Equipment

50 Colours, product description & scope of supply

*"THE ELEGANCE OF
MODERNITY IN A HOME
IS EXPRESSED AND
ENHANCED BY DESIGN
RADIATORS."*



VOGEL&NOOT is Europe's leading technology partner and offers progress on the highest level, paired with a broad product portfolio, covering radiators, panel heating and chimney systems.

Fitters, planners as well as end customers enjoy our continued developments and complete system solutions with functional or extravagant design. They confirm the long-standing success of VOGEL&NOOT.

ENERGY EFFICIENCY AS CORE PRINCIPAL

As an innovative pioneer VOGEL&NOOT has a leading role in the industry and presents future-based heat supply technologies for convenient thermal systems in combination with sustainable protection of the environment.

EXTRAVAGANT DESIGN VARIETY

The design radiators by VOGEL&NOOT set new standards and upgrade modern rooms with their diverse, distinctive appearance and customised workmanship.

INTEGRATED PRODUCT SELECTION AND HIGH-QUALITY SERVICE

As a complete system supplier for heat supply solutions, VOGEL&NOOT not only offers a diversified selection of different product segments, but it also focuses strongly on customised and competent service in all areas.



PROGRESS ON A GLOBAL LEVEL



COMPETENCE WITH PREFECT DESIGN

EXTENSIVE ASSORTMENT

VOGEL&NOOT unites harmony, trendiness and efficient performance and offers a broad range of different products with future-based design radiators, elegant towel warmers, aesthetic convectors and heating walls as well as energy-efficient panel radiators and modernisation radiators. On the European core markets, VOGEL&NOOT presents itself as full-range supplier.

Superior heat distribution technology and diverse design become one and offer first-class solutions. They transform rooms into visually attractive environments.

AN INSTINCT FOR TRENDS

Tastes differ. This is why VOGEL&NOOT engages in a continuous development process, embracing new styles and creating smart heating solutions. Creative design details and good intuition for adding that special something are among the top priorities. For example: The tubes of rounded tube models are not welded together but brayed in a special process, delivering particularly aesthetic and technically impeccable quality. This creates individual and modern heat distributors that enhance every room, either with understatement or striking elements, turning it into one magnificent eye-catcher.

INNOVATIVE THINKING

VOGEL&NOOT operates two own research and development centres in Austria and Germany as well as a design and innovation centre. This ensures the permanent development of VOGEL&NOOT, provides technical improvement and innovative design and is the future-oriented basis of all our work.

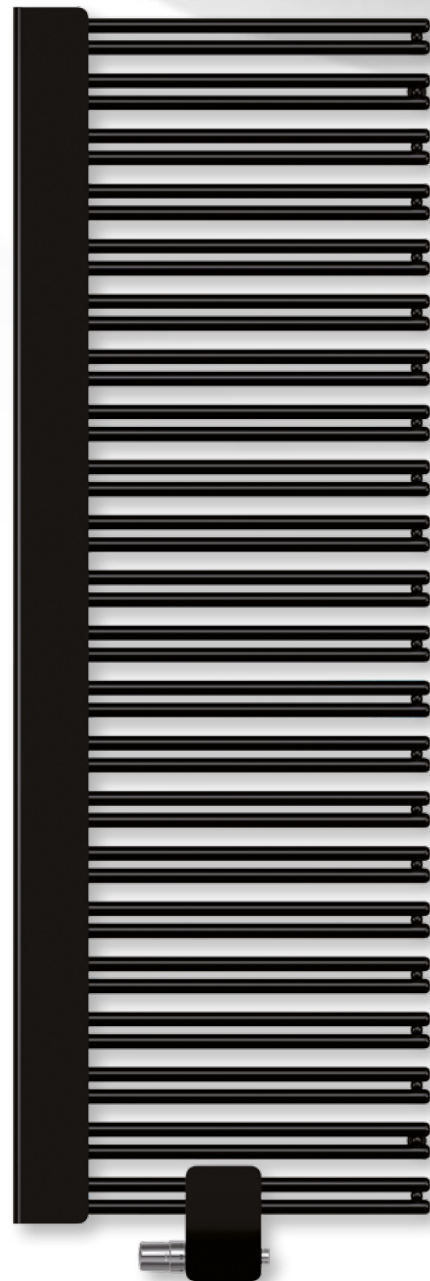



DESIGN RADIATORS

NEWA elegance radiator:
RAL 9016 Traffic White
and RAL 7013 Brown Grey
Furniture SANIJURA

*“MULTIFACETED DIVERSITY
PROVIDES MORE CREATIVE
FREEDOM AND MORE OPTIONS
FOR YOUR INDIVIDUAL
PRODUCT SELECTION!”*



For more information please visit:
http://www.vogelundnoot.com/int/products/design_radiators.htm



BAWA-VM SPA

RELAXATION IN STYLE



The BAWA-VM SPA is a re-defined classic with central connection technology. This design radiator turns your rooms into a classy spa and presents itself with elegance and straight-forward design as well as a harmoniously integrated central connection cover.

YOUR BENEFITS:

With over 70 colours on the sanitary, RAL and special colour charts, the BAWA-VM SPA offers something for everyone's taste. In addition, this model is popular for its easily cleaned vertical covers.

TYPE OVERVIEW BAWA-VM SPA

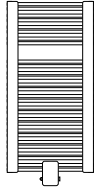
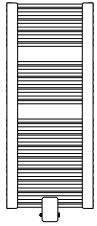
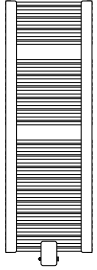
Central valve connection

			
	508, 608, 758	508, 608, 758	508, 608, 758
	1204	1444	1764

Radiators and
softline panels:
S0104 Metal Black

Data in mm.



Radiators and softline panels:
RAL 9016 Traffic White
Furniture LAUFEN MIMO

ELEGANT CLASSIC MEETS MODERN STYLE

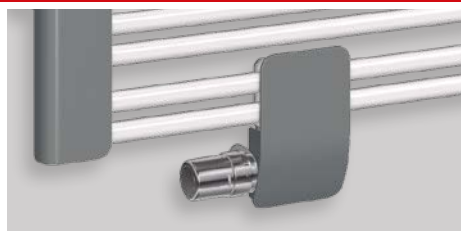



Radiator: RAL 9016 Traffic White
softline panels: RAL 7037 Dusty Grey



Radiators and softline panels:
RAL 9016 Traffic White

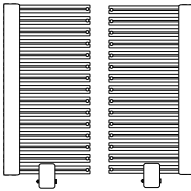
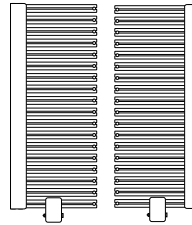
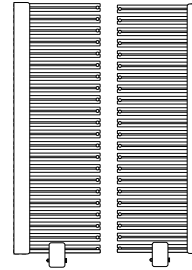

Radiators and softline panels:
RAL 9016 Traffic White
Furniture AKUA

TYPE OVERVIEW FATALA-VM SPA / FATALA-VM SPA LEFT-SIDE DESIGN			
Central valve connection			
			
	505, 605, 755	505, 605, 755	505, 605, 755
	1204	1444	1764

Data in mm.

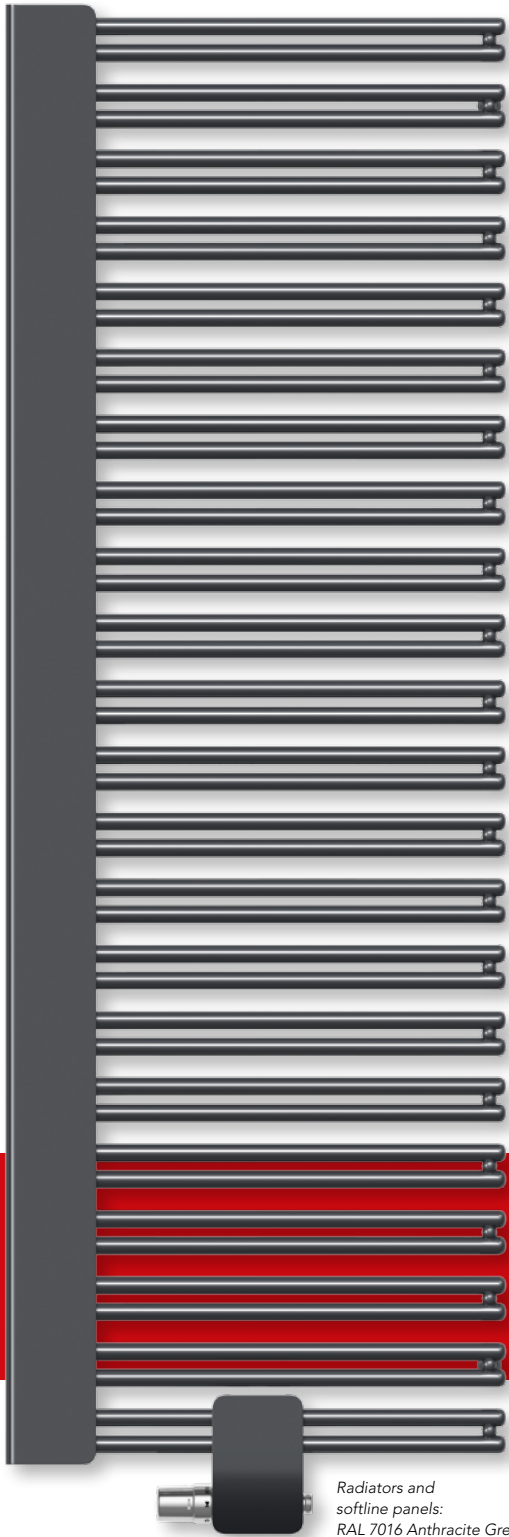

Radiators and softline panels:
RAL 7016 Anthracite Grey

FATALA-VM SPA

EYE-CATCHER WITH PREMIUM DESIGN COMPETENCE

The pioneer in the design radiator segment. With its heating tube that is open on one side and due to the purist, sophisticated design, the FATALA-VM SPA model is compelling in every aspect. This radiator with modern central connection technology stands out due to its incredible user-friendliness and generous space for drying and hanging towels and clothes.

YOUR BENEFITS:

The unique drying device of the FATALA-VM SPA creates an additional first-rate benefit without compromising its elegant design.



Radiator:
RAL 9016 Traffic White
softline panel:
S0088 Manhattan

TRENDY HEATING DESIGN

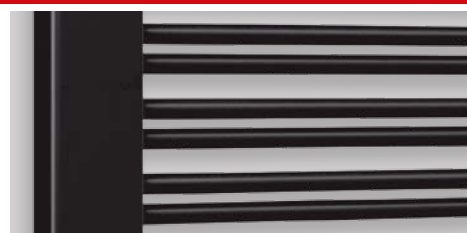

Radiators and softline panels:
RAL 9005 Jet Black

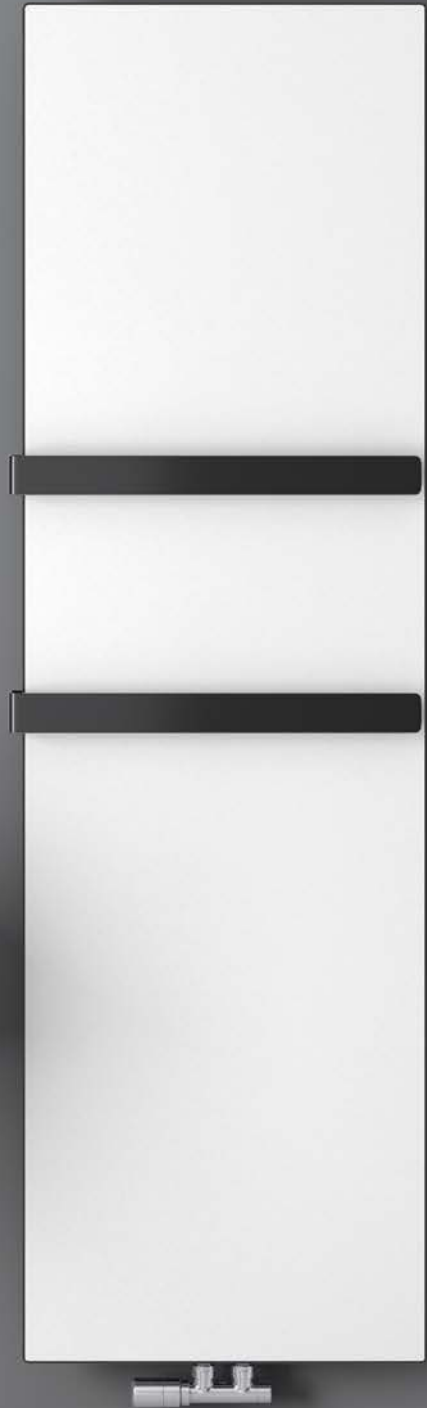

TYPE OVERVIEW NEWA		
Central valve connection		
	514	514
	1430	1730

Data in mm.

*NEWA elegance:
Radiator - basic device and towel frame:
RAL 9005 Jet Black
Front panel: RAL 9016 Traffic White
Furniture FALPER*

NEWA

NEW TREND STANDARDS

Inspired by straightforwardness and youthful esprit, the NEWA model expresses a very special charm. NEWA adds a design statement to every room. The smooth high-gloss finish comes in a great variety of different available colour combinations. In addition, up to three towel holders can be attached that provide optimal drying functions.



YOUR BENEFITS:

The towel holders for the NEWA model are available in open and closed design.

1 NEWA STANDARD

Radiator - basic device,
front panel and towel holders:
RAL 9016 Traffic White

2 NEWA ELEGANCE

Radiator - basic device and
towel frame: S0087 Bahama Beige
front panel: RAL 7015 Slate Grey



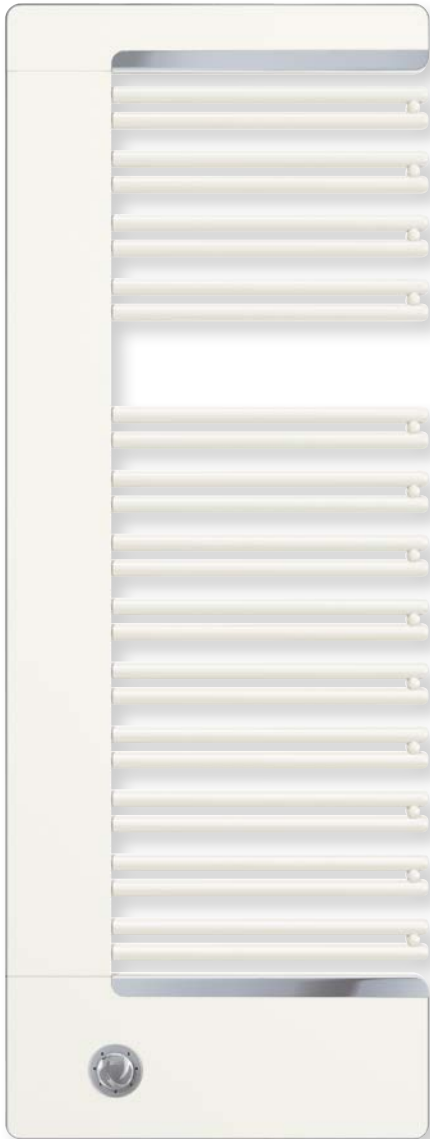

NERO elegance:
RAL 9016 Traffic White

NERO

EXCLUSIVENESS IN PERFECT FORM

A radiator as an eye-catcher? The model NERO makes it possible. The distinctive design has an incomparable character. The chrome-plated frame that is open on one side evokes pure passion for modernity.

YOUR BENEFITS:

The surfaces can be chosen variably and help to create a harmonious, well-balanced room concept that is emphasised by the NERO heat distributor. This way NERO inspires a touch of luxury paired with a great selection of exclusive colour combinations.



1 NERO STANDARD

Radiator - basic device and front cover: RAL 9016 Traffic White
frame: RAL 9007 Grey Aluminium

2 NERO ELEGANCE

Radiator - basic device and front cover: RAL 9005 Jet Black
frame: Chrome



NERO elegance: RAL 9005 Jet Black
Furniture MASTELLA



TYPE OVERVIEW NERO			
with integrated central valve connection			
↕	530	530, 630	530, 630
↕	1019	1419	1819

Data in mm.

SIMPLY DESIGN YOUR OWN PERSONAL NERO MODEL. THE TWO STYLE VARIANTS STANDARD AND ELEGANCE ARE AVAILABLE.



Radiator:
S0104 Metal Black
Furniture EWE

LOWA-VM

PLANE FUNCTIONALITY





The flat tube design of the LOWA-VM model blends seamlessly into any room and offers modern purism in its most elegant form. The high level of functionality of the central connection radiator provides cosiness and comfort as well as excellent heat distribution.

YOUR BENEFITS:

Due to its clearance, the LOWA-VM model is also an optimal laundry and towel drying device.

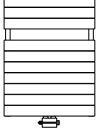
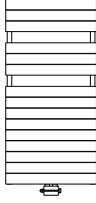
TYPE OVERVIEW LOWA-VM

Central valve connection

			
	↔	↔	↔
	500, 600, 700, 800	500, 600, 700, 800	500, 600, 700, 800
	790	1222	1510

Data in mm.

KASAI

STRIKING AND UNIQUE

What is unique lies in the eye of the beholder - and it is easy to recognise in the KASAI model. With its playful, one-of-a-kind design and heating tubes offset on both sides, KASAI is captivating and adds a highly modern flair to all rooms. A trendsetter second to none.

YOUR BENEFITS:

The offset heating tubes facilitate the hanging and drying of textiles and towels.

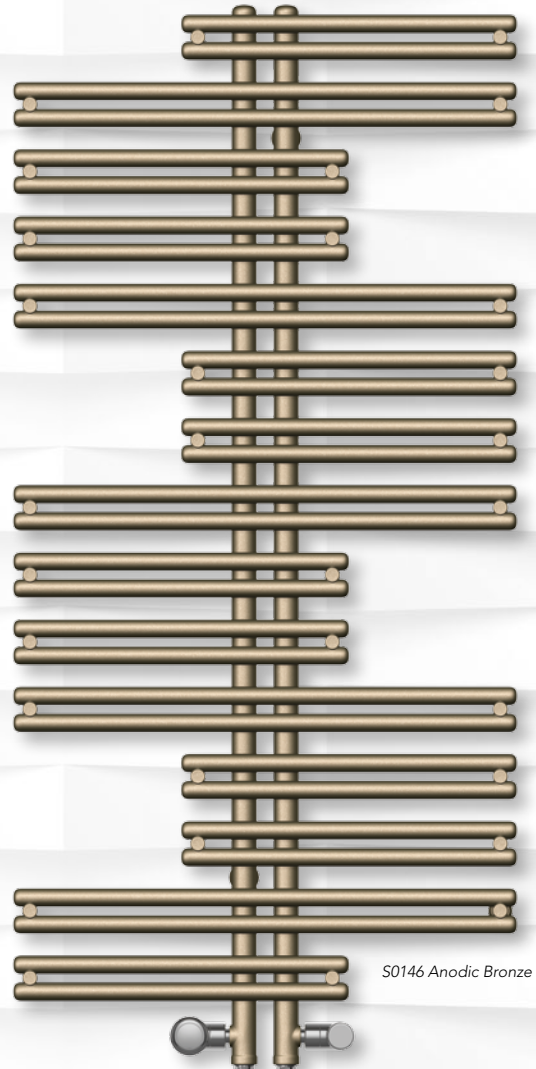

S0146 Anodic Bronze

TYPE OVERVIEW KASAI				
Standard design				
↔	600	600, 750	600, 750, 900	750, 900
↕	1022	1262	1502	1742

Data in mm.

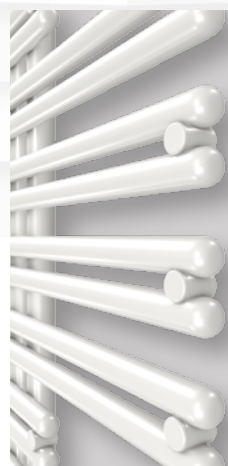

RAL 9016 Traffic White

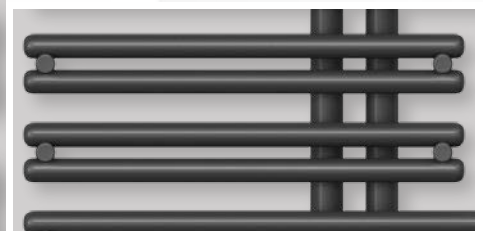

RAL 9005 Jet Black



Radiator:
RAL 9016 Traffic White
Furniture COSIMA



FATALA

PRECISION THAT IS SPOT-ON

The clearly defined shapes of the FATALA model create structure paired with subtle elegance. Furthermore, FATALA also works as an ideal towel drier and offers a high level of flexibility with connections being possible on both sides. A space-saving variant that is also available as E-model.

YOUR BENEFITS:

The model that is open on one side dries and warms towels the simplest possible way and is popular for being a compact multi-talent.

TYPE OVERVIEW FATALA / FATALA-LEFT OPEN ON THE LEFT			
Standard design			
↔	500, 600, 750	500, 600, 750	500, 600, 750
↑	796	1196	1756

Data in mm.

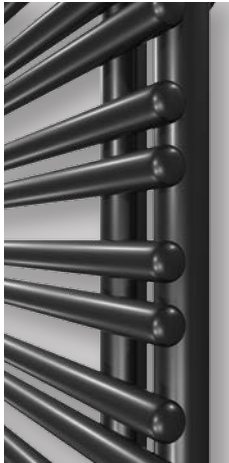

RAL 9005 Jet Black

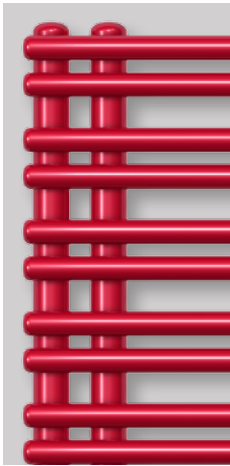

RAL 3000 Flame Red

ARUN-TWIN

THE PARTITION WALL AMONG RADIATORS

Partition of a different sort - offered by the model ARUN-TWIN. The beautiful design and practical functionality transform every room into an extravagant space with numerous options. A variable wall installation is available without any restrictions.

YOUR BENEFITS:

New type of interior design with a functional idea and space for many options.



Radiator:
RAL 9005 Jet Black
Furniture AKUA

TYPE OVERVIEW ARUN-TWIN			
Central valve connection			
500, 600, 750, 900	500, 600, 750, 900	500, 600, 750, 900	
1194	1754	2154	

Data in mm.

BAWA

THE FLEXIBLE EVERGREEN

The BAWA model is a classic design radiator with precise lines and functional components. The heating tubes are arranged in pairs and have a modest visual design. The BAWA design is an unobtrusive asset in every room.

YOUR BENEFITS:

The three different types of connection - standard, central valve connection as well as the offered E-model - offer a high level of flexibility.

RAL 9016 Traffic White

RAL 6019 Pastel green

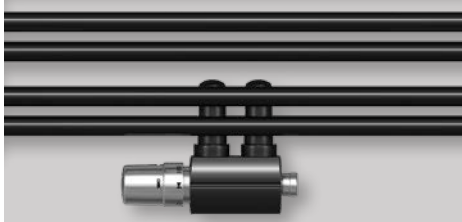
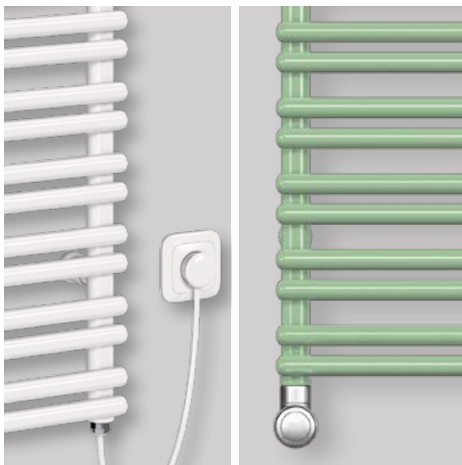

RAL 9005 Jet Black



TYPE OVERVIEW BAWA

Standard design, central valve connection, and E-model

↕	500, 600, 750, 900	500, 600, 750, 900	500, 600, 750, 900
↕	796	1196	1756

Data in mm.

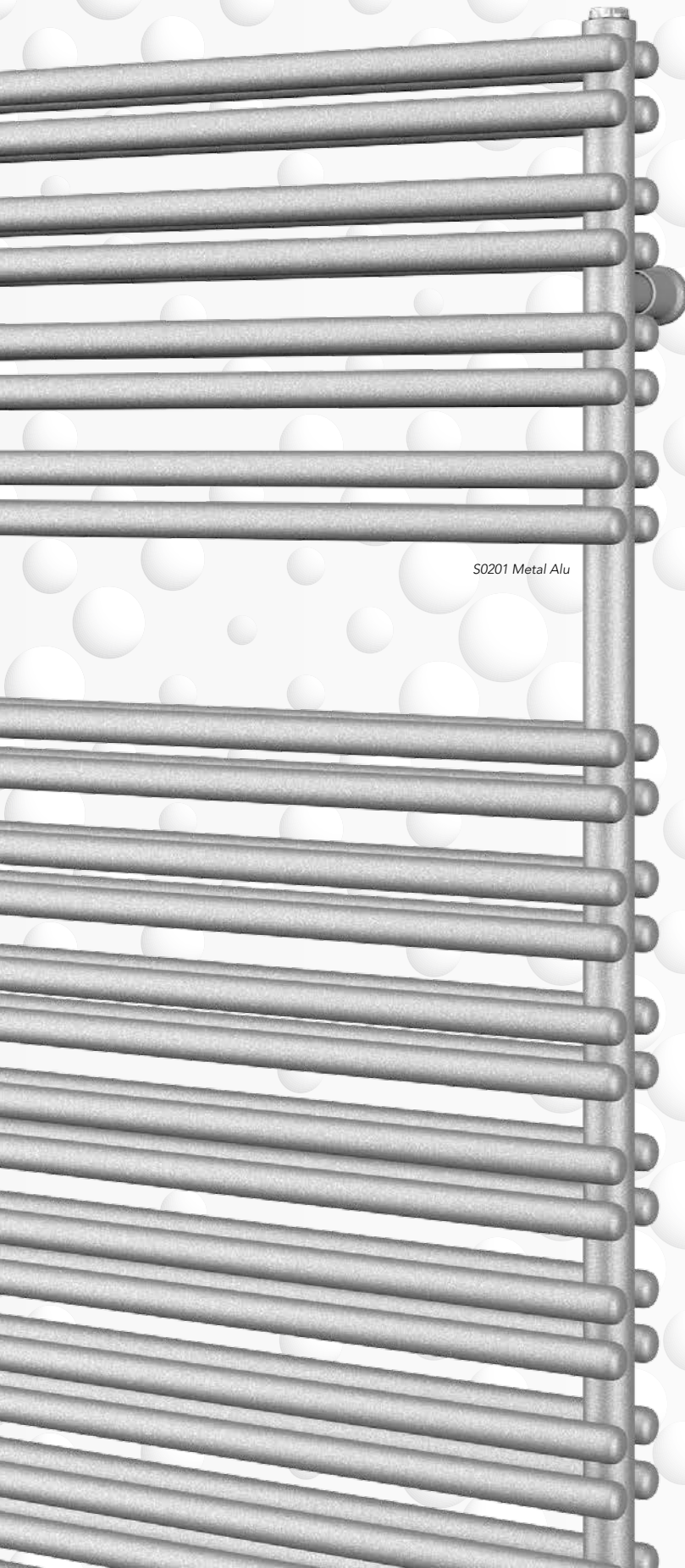

S0201 Metal Alu

BAWA-TWIN **POWERFUL DOUBLE**

The both-sided tubing allows even more efficient, higher heat output. Heat up your rooms in no time and create a very special, comfortable atmosphere. BAWA-TWIN combines optimal heat distribution and short heating time as well as classic design.

YOUR BENEFITS:

The short heating time and increased output create comfort on the highest level, while the additionally required space is very limited.

RAL 9016 Traffic White

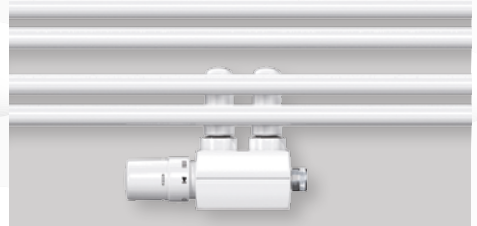

TYPE OVERVIEW BAWA-TWIN

Central valve connection

↕	500, 600, 750, 900	500, 600, 750, 900
↕	1196	1756

Data in mm.



Furniture FALPER



RAL 9005
Jet Black

TYPE OVERVIEW VELINO		
Standard design		
↔	510, 822, 1030	510, 822, 1030, 1238
↑	1600	1800

Data in mm.

VELINO

THE DYNAMIC HIGHLIGHT

Get some dynamic and lively accents into your bathroom. The unique design of the VELINO model is remarkable for its extravagant, wavelike appearance. This design is emphasised by the resemblance to a wardrobe, blurring the boundaries between Furniture and radiator.

YOUR BENEFITS:

This extremely space-saving model with its longitudinally arranged heating tubes makes rooms look bigger.



Radiator:
RAL 9016 Traffic White
Furniture COSIMA

FULDA-VM

ASYMMETRICAL DYNAMICS

The special feature of the FULDA-VM model is obvious at first glance: The asymmetrical form combines an exceptional appearance with a lively curve. A powerfully dynamic creation that is also available as E-model and as standard model.

YOUR BENEFITS: The impressive arrangement of the heating tubes makes the hearts of avant-garde lovers beat faster.

TYPE OVERVIEW FULDA			
Standard design and central valve connection*			
↕	500, 600, 750, 900	500*, 600*, 750*, 900	500*, 600*, 750*, 900
↕	758	1220*	1766*

Data in mm.

CAVALLY

BENT PERFORMANCE





The tubes of the CAVALLY model have a slightly arched shape that create a time-less appearance. It can be integrated into any bathroom in a modern way. The arched form also allows hanging and drying clothes and towels.

YOUR BENEFITS:

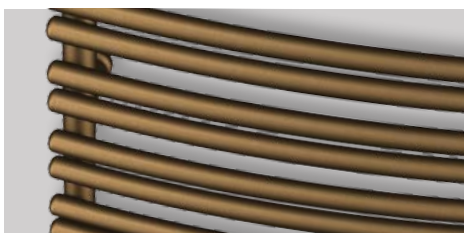
With its slightly arched form, the model adjusts to your requirements and is also available as central valve connection model.

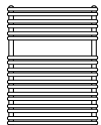
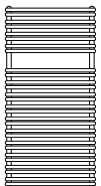
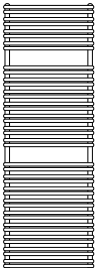
S0147 Anodic Brown



TYPE OVERVIEW CAVALLY			
Standard design and central valve connection			
			
	498, 596, 742, 887	498, 596, 742, 887	498, 596, 742, 887
	796	1196	1756

Data in mm.

RAL 9016 Traffic White





*“ESPECIALLY ELECTRIC
RADIATORS OFFER MORE
FLEXIBILITY AND INDEPENDENCE
IN PLANNING, INSTALLATION
AND OPERATION.”*

ELECTRIC RADIATORS

MARANOA SPEED AIR

ELECTRIC RADIATOR WITH STYLE

A TRUE EYE-CATCHER

The desired shape is clearly defined: Classic elements are combined with massive elements and create a top-class model. With 1000 Watt output, the MARANOA SPEED AIR model delivers cosy heat and comfort in a matter of minutes. With the intelligent hot air fan and its easily legible digital display, operation can be programmed up to 2 hours in advance (10-minute intervals).

YOUR BENEFITS:

- Hot-air fan for quick comfort
- Exact programming
- Premium design open on one side
- High-quality materials
- Practical heating of textiles and towels
- On/off button integrated in the casing

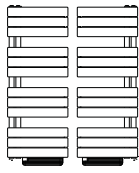
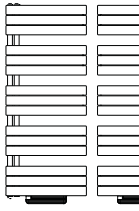
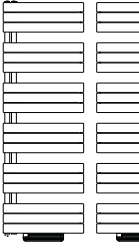
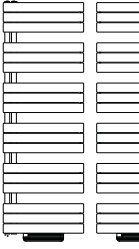
TYPE OVERVIEW MARANOA SPEED AIR / - OPEN ON THE LEFT			
Electric radiator with integrated fan			
			
↔	450	600	600
↑	1192	1492	1792

Data in mm.



Radiator:
RAL 9016 Traffic White
Furniture FALPER

ADDS VALUE TO EVERY ROOM WITH
ITS EXTRAVAGANT DESIGN - AND TOP
COMFORT AT THAT.

LEVO-E

ELECTRIC RADIATOR WITH TIMELESS ELEGANCE

SPACE-SAVING YET POWERFUL

The LEVO-E electric model only requires little space to deliver great comfort. In numbers: The clearance between wall and front edge is merely 89mm. This way it also fits ideally into narrower and smaller bathrooms or kitchens. This does not compromise the heating output in any way and delivers short heating times and optimal heat distribution.

MODESTY IN PERFECT FORM

The LEVO is compelling due to its efficient heating performance with dynamic heat distribution, while it does not leave out the aesthetic touch of great design. Short heating times!

YOUR BENEFITS:

- Elegant look
- Compact dimensions - low depth
- High heat output
- Rich selection of colours and designs
- Towel holder available as stylish accessory

TYPE OVERVIEW LEVO-E			
E-model			
	380, 530, 680	680	680, 830
	1800	1950	2100

Data in mm.

RAL 7015
Slate Grey



Radiator:
RAL 9016 Traffic White
Furniture IDEA Group

DYNAMIC HEAT DISTRIBUTION

SOBER SOPHISTICATION WITH STYLE: THE LEVO-E UPGRADES ALL ROOMS IN A MODERN AND STYLISH WAY.



RAL 9016 Traffic White



S0075 Jasmine



TAHITI SPEED AIR



ELECTRIC RADIATOR WITH FLAIR

“SOUTHSEE FEELING WITHIN MINUTES”

The model TAHITI SPEED AIR brings you a cosy atmosphere within a matter of minutes. Its classic design stands out for its both-sided, closed tubing. In its E-variant it offers rapid heat through the installed hot-air fan. The intuitive digital display provides high flexibility and allows exact programming for up to 2 hours of uninterrupted operation (adjustable in 10-minute intervals).

YOUR BENEFITS:

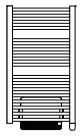
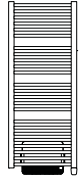
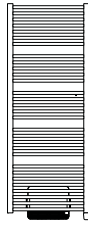
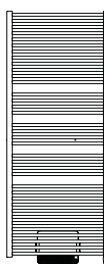
- Speed air fan with 1000 Watt
- Shortest possible room heating times
- Exactly programmable heating times
- Closed rounded tube design
- Convenient steel-made towel drier

TYPE OVERVIEW TAHITI SPEED AIR					
Electric radiator with integrated fan					
					
	500	500	500	600, 750	750
	547	862	1222	1537	1807

Data in mm.

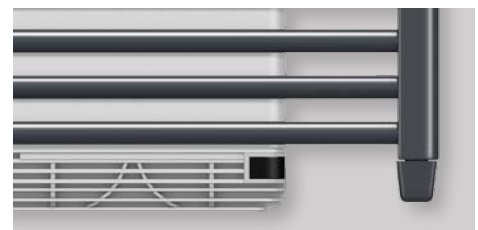

RAL 7016 Anthracite Grey

THE CLASSIC PREMIUM PARTNER IN THE ELECTRIC RADIATOR SEGMENT WITH UNDERSTATEMENT IN ITS DESIGN.





Radiator:
S0149 Anodic Natura
Furniture MASTELLA

FULDA-E

ELECTRIC RADIATOR WITH A DYNAMIC CURVE

The FULDA-E model is a dynamic variant of conventional E-radiators. The generously arranged heating tubes ensure optimal heat distribution and space for drying towels and textiles of all kind. The short heating time combines harmony and comfort with a dynamic lightness.

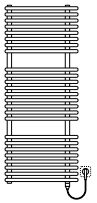
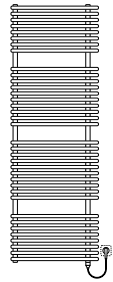
YOUR BENEFITS: The larger clearance behind the FULDA-E model ensures an even better drying effect for textiles.

TYPE OVERVIEW FULDA-E		
E-model		
	500, 600	
	1220	1766

Data in mm.

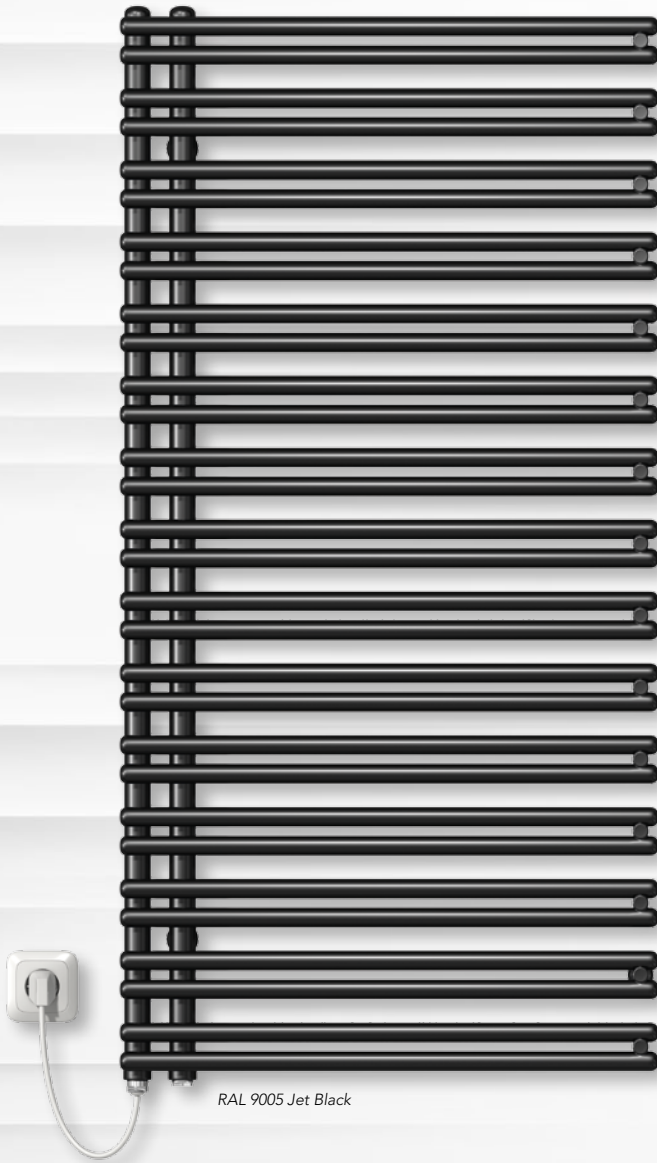

RAL 9005 Jet Black

FATALA-E

**ELECTRIC RADIATOR -
IMPLEMENTED WITH PRECISION**

The purist design of the FATALA-E model expresses itself well through the heating tubes that are kept open on one side. In addition, the straight-forward construction of this E-radiator is also a practical towel holder and drier. The broad variety of dimensions also allow flexible planning and installation.

YOUR BENEFITS:

Exciting, modern and new trendy colours offer the right design for every taste.

TYPE OVERVIEW FATALA-E / FATALA-E OPEN ON THE LEFT			
E-model			
↔	500	500, 600	600
↑	796	1196	1756

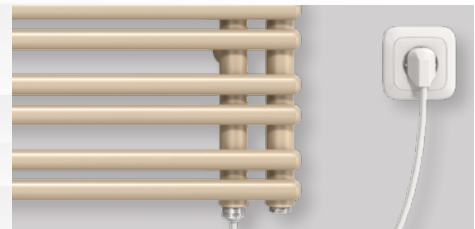

S0087 Bahama Beige

BAWA-E

ELECTRIC RADIATOR WITH A SUBTLE APPEARANCE

The elegantly arranged double-tube design of the BAWA-E can be integrated perfectly in any room. Efficient heating technology and quick heating times are seamlessly combined with the classic design of this model.

YOUR BENEFITS:

Kept in a classic style, the BAWA-E fits everywhere and leaves a stylish and trendy impression.



TYPE OVERVIEW BAWA-E			
E-model			
	500	500, 600	600
	796	1196	1756

Data in mm.

Radiator:
RAL 9016 Traffic White
Furniture TEAM 7



Furniture COSIMA

DELLA-E

MODEST SUPERIORITY

The DELLA-E model is remarkable for its simple design as a classic rounded-tube radiator and its practical application in a merely electric form.

YOUR BENEFITS:

Due to the unlimited usability of the electric heating element, the DELLA-E is available all year round, independently and without influencing your heating system.

TYPE OVERVIEW DELLA-E		
E-model		
	500, 600	500, 600
	1136	1766

Data in mm.



*"CLASSIC DESIGN AT
ITS BEST: MAXIMUM
FLEXIBILITY AND TOP
PERFORMANCE!"*

TOWEL WARMERS



For more information please visit:
<http://www.vogelundnoot.com/int/products/towelwarmers.htm>





ABUNA-M

SMART FUNCTIONALITY

The ABUNA series embodies the classic, elegant design of a rounded-tube radiator. The modest design of this towel warmer creates a stylish environment with a feel-good factor.

YOUR BENEFITS:

The narrow heating tubes provide optimal space for hand towels and bath towels.

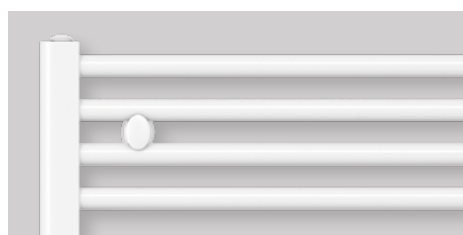

TYPE OVERVIEW ABUNA-M			
Central valve connection			
↕	500, 600, 750, 900	500, 600, 750, 900	500, 600, 750, 900
↑	714	1134	1764

Data in mm.



DION AND DION-VM

ADVANCED PERFECTION IN SHAPE

The DION series is impressive due to its modest, stylish design of a rounded-tube radiator. The DION-VM is the extended version with central connection and stands out for its harmonious interplay of cosiness and aesthetics.

YOUR BENEFITS:

The horizontally arranged, narrow heating tubes create space for hand towels and bath towels and provide additional storage space for your bathroom.

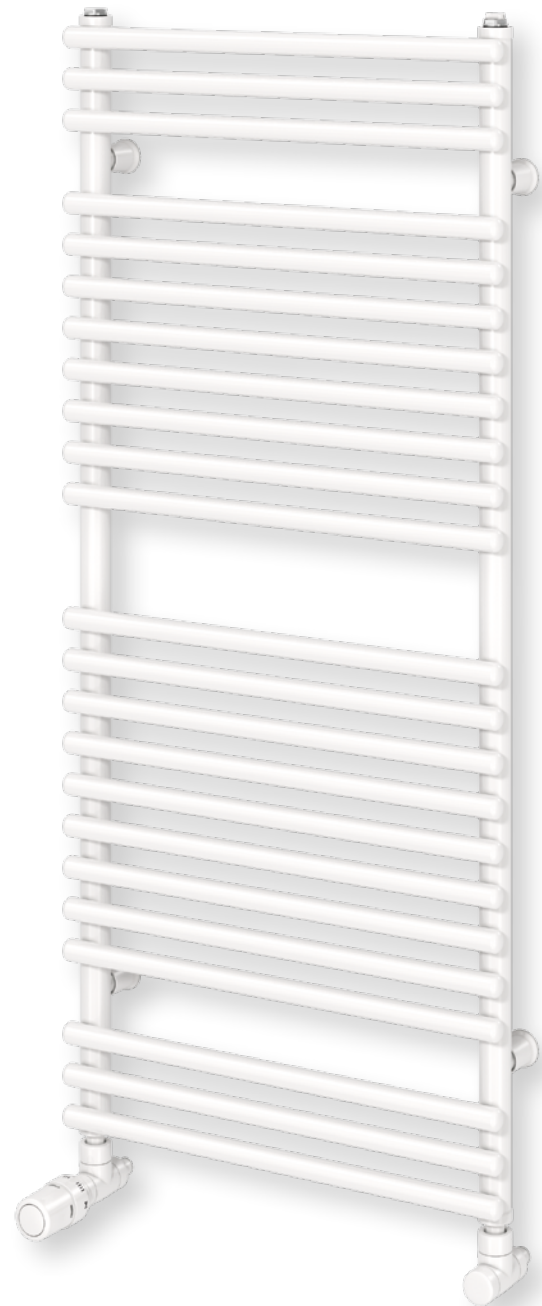
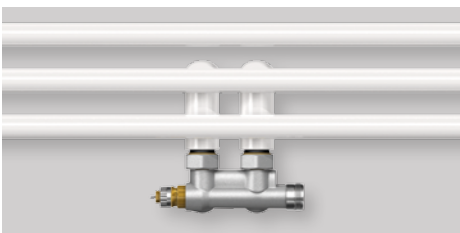

TYPE OVERVIEW DION AND DION-VM			
Standard design and central valve connection			
↔ 500, 600, 750, 900	↔ 500, 600, 750, 900	↔ 500, 600, 750, 900	
↑ 714	↑ 1134	↑ 1764	

Data in mm.



Radiator:
RAL 9016 Traffic White
Furniture LAUFEN MIMO

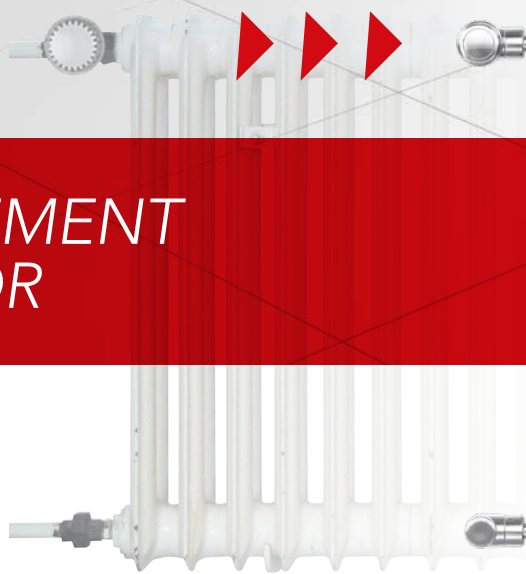

REPLACEMENT RADIATOR

RAL 9005
Jet black



*“PERSONALLY, I CANNOT DO
WITHOUT REPLACEMENT
RADIATORS ANYMORE, ESPECIALLY
FOR RENOVATION WORK, DUE TO
THEIR SIMPLE AND DIRT-FREE
INSTALLATION!”*



For more information, please visit:
http://www.vogelundnoot.com/int/products/replacement_programme.htm



Radiator: RAL 9016 Traffic White
Furniture FALPER

TYPE OVERVIEW BAWA / BAWA-TWIN MOD.		
Standard design		
	500, 600	500, 600
	1196	1756

Data in mm.

MODERNISING WITH BAWA AND BAWA-T

CLASSIC AESTHETICS

The stylish classics, BAWA and BAWA-T, present themselves in their timeless and straight-forward design. Not only will they create a comfortable, cosy atmosphere in your rooms, but they will also provide a touch of subtle elegance.

YOUR BENEFITS:

The BAWA and BAWA-T models deliver maximum functionality in perfect harmony with elegant and subtle design statements.

FACTS:

- Suitable for all existing connections
- Quick modernisation without any dirty work
- Suitable for low-temperature systems



RAL 7016 Anthracite Grey

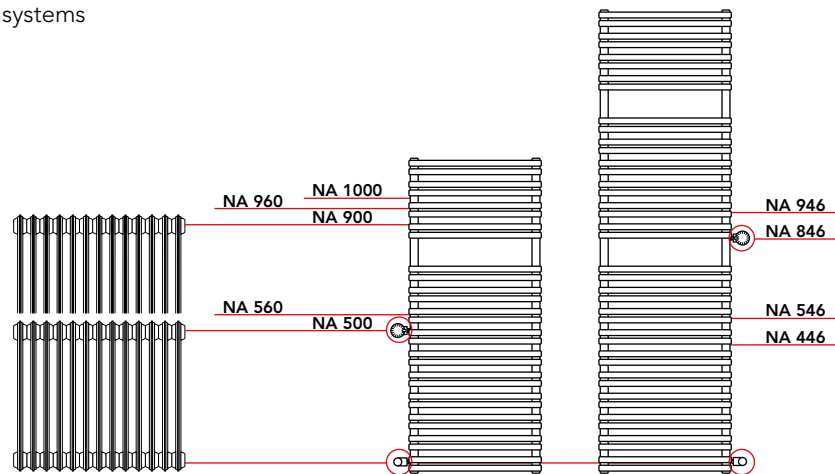

DIN-SECTIONAL RADIATORS				
Boss spacing [mm]	Type [mm]	Construction depth [mm]	Construction height [mm]	Heat output (W/m)
				90/70/20 °C
500	500/220	220	600	2560
900	900/110	110	1000	2440
900	900/160	160	1000	3140
Radiators to be replaced:				
All old DIN sectional radiators and panel radiators with boss spacing 446mm to 1000mm				

MODERNISATION WITH DESIGN RADIATORS					
New model	Construction depth [mm]	Construction length [mm]	Construction height [mm]	Heat output (W/m)	
				90/70/20 °C	75/65/20 °C
BAWA-T	113	600	1754	1844	1466
BAWA-T	113	600	1754	1844	1466
BAWA-T	113	600	1754	1844	1466
Our replacement recommendations:					
BAWA and BAWA-T: CH = 1200 and 1800 mm, CL = 500 and 600 mm Boss spacing 500, 900, 1000 mm and boss spacing 446, 546, 846, 946 as well as 560 and 960 mm					

Note: The above examples are merely for reference.

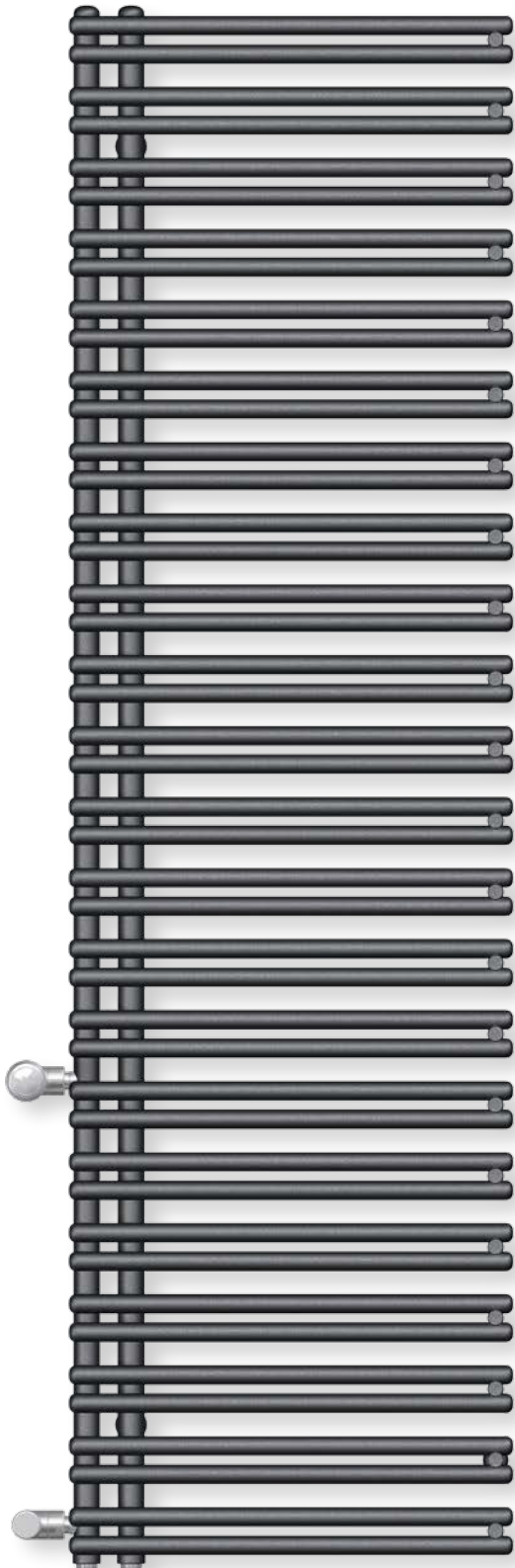

S0148
Anodic Black

MODERNISING WITH FATALA

CREATIVE FUNCTIONALITY

The FATALA model will be a modern eye-catcher in your home. The striking shape not only provides efficient heating with a 1:1 exchange due to the same boss spacing, but it is also a practical hand towel holder with drying function. Get a fresh spirit into your rooms! With the extensive selection of RAL colours and sanitary colours it will be both fun and easy to do.

YOUR BENEFITS:

The FATALA model unites simple exchange and modern design.

FACTS:

- Can be combined with existing connection dimensions
- Energy saving through efficient heat distribution
- Available in left and right-hand-side design

TYPE OVERVIEW FATALA / FATALA-OPEN ON THE LEFT MOD.		
Standard design		
	500, 600	500, 600
	1196	1756

Data in mm.



Radiator: RAL 9016 Traffic White
Furniture COSIMA

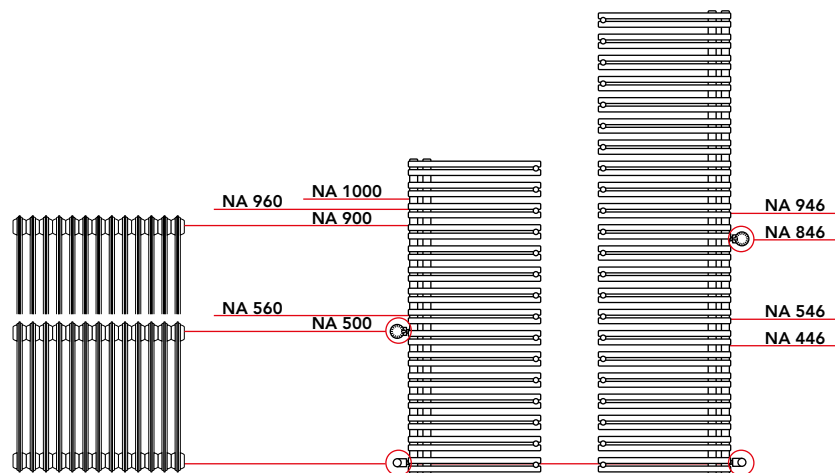

DIN-SECTIONAL RADIATORS				
Boss spacing [mm]	Type [mm]	Construction depth [mm]	Construction height [mm]	Heat output (W/m)
				90/70/20 °C
350	350/160	160	450	1480
Radiators to be replaced:				
All old DIN sectional radiators and panel radiators with boss spacing 446mm to 1000mm				

MODERNISATION WITH DESIGN RADIATORS					
New model	Construction depth [mm]	Construction length [mm]	Construction height [mm]	Heat output (W/m)	
				90/70/20 °C	75/65/20 °C
FATALA*	97	600	1756	1356	1081
Our replacement recommendations:					
FATALA/FATALA open to the left: CH = 1200 and 1800 mm, CL = 500 and 600 mm NA 500, 900, 1000 mm and NA 446, 546, 846, 946 as well as 560 and 960 mm					

* Connection with modernisation adaptor (see pamphlet on panel radiators
Note: The above examples are merely for reference.



FUNCTIONAL ACCESSORIES

The towel warmers and design radiators by VOGEL&NOOT offer a large number of practical accessories that have been created with style and elegance as well as functional value.

The additional components can also be retrofitted very easily. Create additional shelf space or hangers in no time.

The chrome-plated variants further upgrade the design radiators and are highly compatible with the individual models.

LIMITLESS
VARIETY

ABUNA-M, DION/DION-VM, DELLA-E



BAWA/BAWA-E, FATALA/FATALA-E, ARUN-TWIN, KASAI

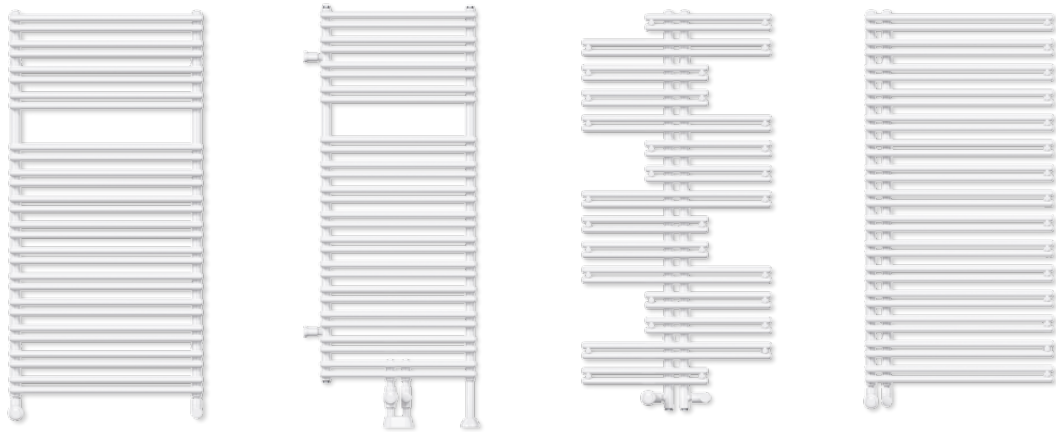

ACCESSORIES



Laundry bar



Bath towel holder





Glass shelf







Towel ring



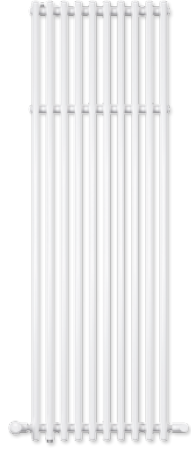

Hand towel holder

CAVALLY, FULDA/FULDA-E	
	
ACCESSORIES	
	
Towel ring	
	
Hand towel holder	

VELINO	
	
ACCESSORIES	
	
Laundry bar	
	
Hand towel holder	Wardrobe hook

NEWA	
	ACCESSOIRES
	
	Closed hand towel holder
	
Open hand towel holder	

LEVO-E	
	ACCESSOIRES
	
	Hand towel holder



PTC-E- HEATING ELEMENTS

The PTC-E heating elements bridge the gap of the heating free time in an ideal manner and create a cosy atmosphere with short heating times. Depending on the size of the radiator with ratings from 300, 600 to 900 Watt they quickly deliver comfortable heat. The PTC-E heating element can also be retrofitted on almost all design radiators by VOGEL&NOOT.

TEMPERATURE REGULATION FOR PTC-E HEATING ELEMENTS

If a design radiator is operated with a PTC-E heating element, a room thermostat allows the ideal regulation of the room temperature.

INFRARED CONTROL SET

This set includes everything: From a digital room thermostat with infrared transmission to a PTC electric heating element. The infrared transmitter features a clearly structured LCD screen showing room temperature, set temperature, operation mode and BOOST symbol all on one display.



EFFICIENT HEATING IN
TRANSITIONAL SEASONS

STANDARD COLOUR

RAL 9016 Traffic White

RAL COLOURS

RAL 9010 Pure White	RAL 9001 Cream White	RAL 250-2 Lemon Glow	RAL 1023 Traffic Yellow	RAL 1012 Lemon Yellow	RAL 1004 Golden Yellow	RAL 1027 Curry	RAL 6034 Pastel Turquoise
RAL 5014 Pigeon Blue	RAL 5009 Azure Blue	RAL 5015 Sky Blue	RAL 5017 Traffic Blue	RAL 5022 Night Blue	RAL 5002 Ultramarine Blue	RAL 5001 Green Blue	RAL 9005 Jet Black
RAL 7021 Black Grey	RAL 1033 Dahlia Yellow	RAL 2003 Pastel Orange	RAL 2004 Pure Orange	RAL 3000 Flame Red	RAL 3005 Wine Red	RAL 4002 Red Violet	RAL 4007 Purple Violet
RAL 4008 Signal Violet	RAL 290 70 20 Mauve Haze	RAL 290 40 45 Mystic Purple	RAL 4009 Pastel Violet	RAL 3015 Light Pink	RAL 3014 Antique Pink	RAL 6019 Pastel Green	RAL 120 80 60 Modern Green
RAL 120 70 70 E-Green	RAL 150 60 60 Green Apple	RAL 6033 Mint Turquoise	RAL 6004 Blue Green	RAL 8017 Chocolate Brown	RAL 8019 Grey Brown	RAL 040 80 05 White Coffee	RAL 7035 Light Grey
RAL 7040 Window Grey	RAL 7001 Silver Grey	RAL 7037 Dusty Grey	RAL 7030 Stone Grey	RAL 7013 Brown Grey	RAL 7015 Slate Grey	RAL 7016 Anthracite Grey	RAL 7024 Graphite Grey
RAL 9006 White Aluminium	RAL 9007 Grey Aluminium						

SANITARY COLOURS

S0075 Jasmine	S0091 Pergamon	S0094 Natura	S0087 Bahama Beige
S0084 Anemone	S0077 Magnolia	S0164 Banana	S0088 Manhattan

SPECIAL COLOURS

S0145 Crème White	S0142 White Textured ¹	S0141 Black Textured ¹	S0147 Anodic Brown
S0148 Anodic Black	S0149 Anodic Natura	S0201 Metal Alu ²	S0102 Metal Grey ²
S0146 Anodic Bronze	S0104 Metal Black ²	S0144 Brown Grey	S0143 Light Grey

The towel warmers **DION** and **DION-VM** as well as the electric radiator **DELLA-E** are available in RAL 9016 traffic white.

The ABUNA-M towel warmer is available in RAL 9016 traffic white and chrome.

The colours shown here are not binding. Colour variations are possible due to print-technical reasons.

Other colours are available on request!

¹ With structured surface

² With rough surface

PRODUCT DESCRIPTION AND SCOPE OF SUPPLY

The design radiators by VOGEL&NOOT offer an elegant and stylish alternative to classic radiators and are available in a broad variety of different models, all manufactured in premium quality. The different models of the towel warmer series by VOGEL&NOOT are high-quality design branded products that will blend in perfectly in your bathroom. The unobtrusive design is remarkable for its subtle visual appearance.

Depending on the relevant model, the following designs are available. All products are supplied in ready-to-install protection packaging.

MODELS WITH CLASSIC CONNECTIONS

They come with blind plugs and air-bleeding plugs as well as a wall-mounting set in the relevant colour of the radiator.

MODELS WITH CENTRAL VALVE CONNECTIONS

All models come ready for installation with sealed-in blind plugs and air-bleeding plugs ex works as well as wall-mounting sets in the relevant colour of the radiator, an enclosed valve connection fitting with covering collar in the relevant colour of the radiator. This applies to the models ABUNA-M, DION-VM, BAWA-VM SPA, FATALA-VM SPA, BAWA-VM, BAWA-T-VM, LOWA-VM, FULDA-VM and CAVALLY-VM as well as an integrated connection fitting with thermostat button for NERO. Depending on whether it is a single or double-tube system, the NEWA model also comes with valve connection fittings. Single-tube system: Danfoss valve connection fitting and covering collar (without thermostat button) or double-tube: Poletti design valve set (incl. thermostat button)

DESIGNED AS PARTITION WALL

The ARUN-TWIN model is used as partition wall. The individual room partition makes ARUN-TWIN an attractive interior design element for all living areas. Supplied including blind plugs and air-bleeding plugs as well as wall-mounting and floor-mounting sets in the relevant colour of the radiator.

REPLACEMENT RADIATORS

The models BAWA, BAWA-TWIN, FATALA and FATALA, open on the left side, are supplied as replacement radiators with classic connections with the desired boss spacing, including a wall-mounting set in the relevant colour of the radiator.

MODELS FOR ELECTRIC OPERATION ONLY

The electric radiators of the families DELLA-E, BAWA-E, FULDA-E and FATALA-E as well as the models MARANO SPEED AIR, TAHITI SPEED AIR and LEVO-E have been designed for electric heating only, without any connection to the central heating system. Self-regulation effect: The temperature-based PTC-E heating element regulates the temperature of the heat transporting fluid in the radiator automatically - not adjustable - by modifying the electric resistance (only applies to BAWA-E, FULDA-E and FATALA-E). They are supplied including the wall mounting in the relevant colour of the radiator (exception: LEVO-E).

OPERATING CONDITIONS

For all models a maximum operating temperature of 110 °C has been defined.

MOUNTING SET

At the back of each towel warmer and design radiator there is a wall mounting device that allows the orientation of the radiator in horizontal and vertical direction.

SURFACE TREATMENT

High-quality, environmentally friendly 2-layer varnish according to DIN 55900, ATL primer with electrophoretic varnish, using water-soluble varnish; electrostatic powder coating.

PACKAGING

Support protection, face protection, double-wall cardboard and PE film.

Technical modifications reserved!



CERTIFIED BRANDED PRODUCTS

VOGEL&NOOT is a synonym for premium branded products meeting the highest quality standards in manufacture and operation. The quality and performance data for towel warmers and design radiators by VOGEL&NOOT are subject to constant testing by renowned and independent European institutes. They guarantee the safety with regard to the economically designed heating performance to the highest possible extent as well as excellent product quality.

For more information please visit:
www.vogelundnoot.com/int/

Rettig Austria GmbH Vogel und Noot Straße 4, 8661 St. Barbara, Austria
T: +43 3858 601-0, F: -1298, info@vogelundnoot.com, www.vogelundnoot.com/int/